



New Flagship Bench-top DC Power Supply



New

Compact Wide Range DC Power Supply **PWR-01 Series**

A wide range of voltage and current settings can be combined within its output power rating (3 to 4 times)

LAN (LXI compliant) /USB/RS232C as standard interface

Sequence creation software : Wavy for PWR-01

All models are equipped with front output terminals as standard

Variable internal resistance function

The Bench-top

New flagship bench-top DC power supply

L, ML, MH, and H voltage types. Lineup of 12 models in total!

The PWR-01 is a series of high performance, multifunctional, compact, wide-range DC power supplies. It consists of 12 models in total with 4 maximum voltage outputs (L, ML, MH, and H) and 3 maximum power outputs (400 W, 800 W, and 1200 W). The series is equipped with LAN (LXI), USB, and RS232C as standard interfaces that are essential for system integration. The PWR-01 also features front-facing output terminals, variable internal resistance, bleeder ON/OFF functions, CC/CV priority switching function, synchronized operation, various protections, and programmable internal memory.



Lineup

40 V type

Type	Model	Voltage output	Current output	Power output
L	PWR401L	0 V to 40 V	0 A to 40 A	400 W
	PWR801L		0 A to 80 A	800 W
	PWR1201L		0 A to 120 A	1200 W

80 V type

Type	Model	Voltage output	Current output	Power output
ML	PWR401ML	0 V to 80 V	0 A to 20 A	400 W
	PWR801ML		0 A to 40 A	800 W
	PWR1201ML		0 A to 60 A	1200 W

240 V type

Type	Model	Voltage output	Current output	Power output
MH	PWR401MH	0 V to 240 V	0 A to 5 A	400 W
	PWR801MH		0 A to 10 A	800 W
	PWR1201MH		0 A to 15 A	1200 W

650 V type

Type	Model	Voltage output	Current output	Power output
H	PWR401H	0 V to 650 V	0 A to 1.85 A	400 W
	PWR801H		0 A to 3.70 A	800 W
	PWR1201H		0 A to 5.55 A	1200 W

Actual size

Universal Communication Interface Combined with Wide Range Output Coverage!

Sequence Function

Synchronized operation using trigger signals

Communication Interface

LAN (LXI compliant) /USB/RS232C as standard interface

Front Output Terminals

Equipped with front output terminal as standard *Up to 10 A

Wide Range

3 to 4 times coverage ratio for voltage and current range

Variable Internal Resistance Function

Easy simulation of power supplies carrying internal resistance made possible

Durable Performance

Operating temperature guaranteed up to 50 °C.



at 50°C (122°F)
 capable of operating at full load continuously

Convenient sequence generation for the PWR-01

Sequence Creation Software

SD027-PWR-01
 (Wavy for PWR-01)



For details, please refer to page 15.



1200 W model

800 W model

400 W model

Compact Wide Range DC Power Supply

PWR-01 Series

NEW

■ Safe and easy to use front-facing output terminals

All models are equipped with front-facing output terminals (up to 10 A) optimized for bench-top use. Please connect to the output terminals with a safety plug. *This product's specifications were recorded using the back-side output terminals.



● Safety plugs (Options)



TL41 (screw connection type)
Red and black, one set each
1000 V/ CATII max 32 A



TL42 (solder connection type)
Red and black, one set each
1000 V/ CATII max 32 A

■ Sequence function

The sequence function allows you to automatically execute programs that you have set in advance one operation at a time. However, you cannot create sequences using only the panel. Sequence programs are created using commands from a PC. Once a sequence is executed via remote control, the program is saved onto the PWR-01's internal memory and then can be executed directly from the front panel without a PC.

■ Synchronized operation

Synchronized operation allows for settings and sequence programs to be synchronized via trigger signals. Different PWR-01 models (e.g., 400 W model and 800 W model) can be easily mixed and matched with no difficulties. Synchronized operation is also possible in parallel operation. In order to successfully synchronize your power supplies, please configure various settings using remote control commands. After completing configuration, synchronized operation can be performed without a PC.

■ Standard communication interface

The series has been equipped with LAN (LXI), USB, and RS232C as standard interfaces, essential for system integration. When using RS232C, please order the D-sub 9P-RJ45 transformation cable (RD-8P/9P) option, sold separately. The PWR-01 has also been equipped with J1/J2 connectors for analog control.

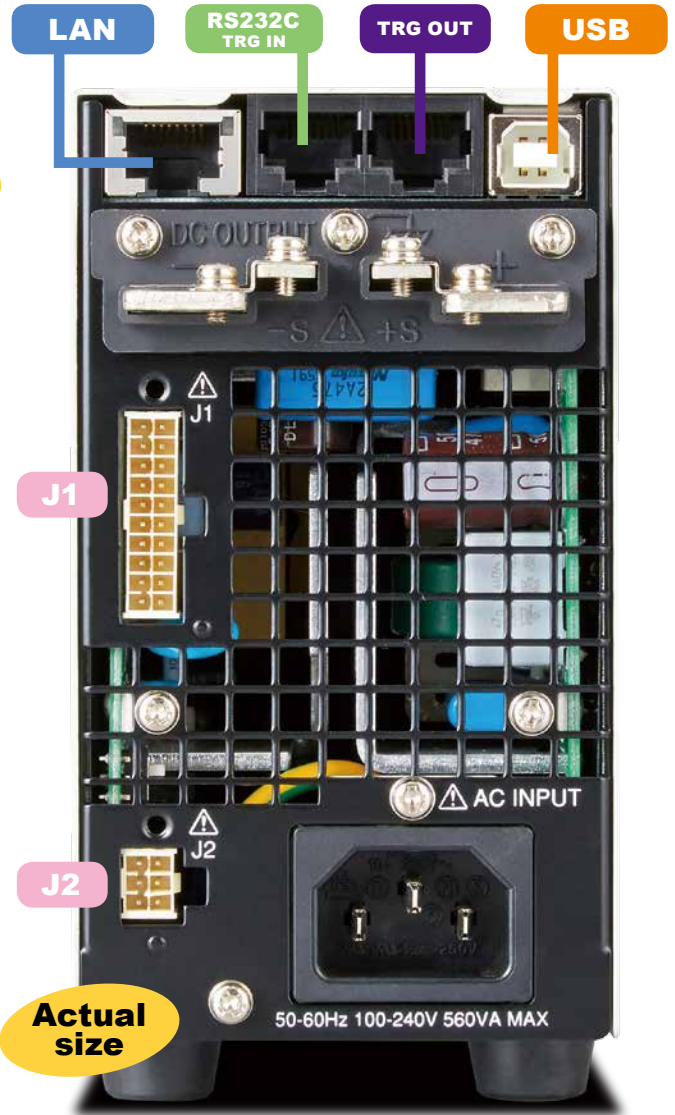

Rear Panel : 400 W model

Sequence Function/Synchronized Operation Concept Map

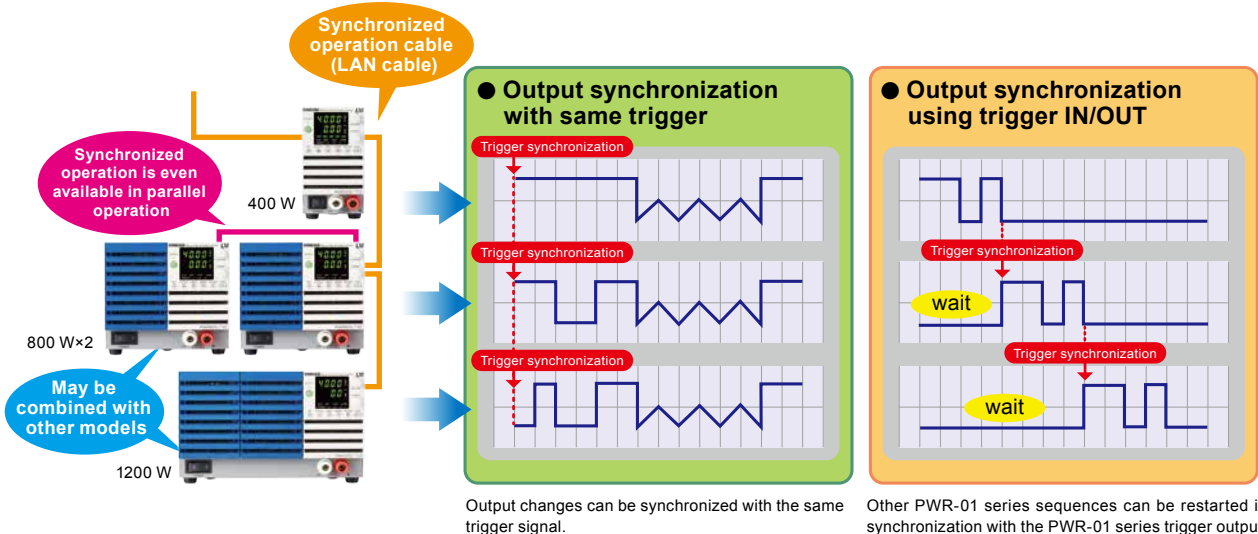

■ Bleeder ON/OFF function

The PWR-01's capacitor is connected to its output terminals, with a bleeder circuit equipped that discharges electricity when the OUTPUT is set to OFF. For example, when a battery is connected to the output terminal, when the bleeder circuit is set to ON, the bleeder circuit will discharge electricity from the battery even when OUTPUT is OFF. In cases like these, excessive electric discharge can be prevented by setting the bleeder circuit to OFF.

This makes it possible to prevent current backflow from a battery without using a diode.

Bleeder circuit	Description
Off *1	Bleeder circuit off
Normal bleeder	Bleeder circuit on
Hyper bleeder *2	When a normal bleeder is used, falling time with no load can be shortened to approximately 70% and eliminate test cycle time. This is effective for situations in which one wants to operate ON/OFF with capacitive load as quickly as possible.

*1. Even if the output terminals are open and the output is turned off or the voltage setting is at 0 V, up to several hundred millivolts of voltage may appear across the output terminals.

*2. The fan speed is fixed to the maximum speed.

■ Customizable startup when turning on output

You can choose the priority operation mode (CC priority/CV priority) when the output is turned ON.

This can prevent overshoot when turning on the output.

■ Output ON/OFF delay function

You can set the delay (DELAY TIME) from when the OUTPUT key is turned on or off to when the output actually turns on or off.

This is useful for tests where precise timing/order of rise and drop voltage is essential according to the load characteristics.

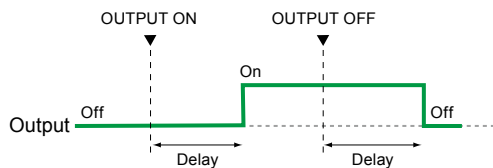

■ Soft start/stop function

You can set the rise time and fall time of output current. This is useful when the load cannot follow the sudden rise or fall in the output current or when you want to avoid the overcurrent protection from being activated.

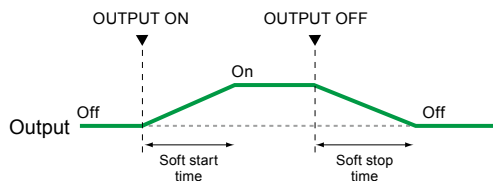

■ Master-slave parallel operation

One-control parallel operation is performed by designating one "master" device and connecting it to one or more of the same models being the "slave" devices. The entire system can then be controlled by operating the master machine. Output current can be greatly amplified (maximum output current: single rated output current x number of parallel units) with one-control parallel operation. The maximum number of parallel units including the master device is 3 units for the 400 W and 800 W models and 2 units for the 1200 W models. Differences in output voltage and output current between the master and slave devices are within approximately 5% of their respective rated output.

■ Series operation

Up to two units can be connected in series (excluding the H type). The total combined output voltage of the two units is applied to the load. The voltage setting accuracy is the same as the accuracy of an individual unit. *You cannot perform master-slave configuration in series operation.

■ Preset memory function

The preset memory function of the PWR-01 allows you to save up to three combinations of each of the voltage, current, OVP, OCP and UVL values. The saved preset values can be recalled from the preset memory found on the front panel.

■ CONFIG setting shortcut function

You can register CONFIG setting parameters to the front panel's SC keys. You can perform tests efficiently by registering CONFIG parameters that you use frequently without consulting the CONFIG menu. Up to three parameters can be registered.

■ Multi-channel (VMCB) * *virtual multi-channel bus (VMCB)

When multi-channel (VMCB) is used, one personal computer can be connected to multiple PWR-01 series machines (up to 31 units) to construct a virtual multi-channel power source system. This is effective for matching the control timing of multiple PWR-01 series units and for saving communication ports.

● Basic configuration with LAN interface and VMCB (example)

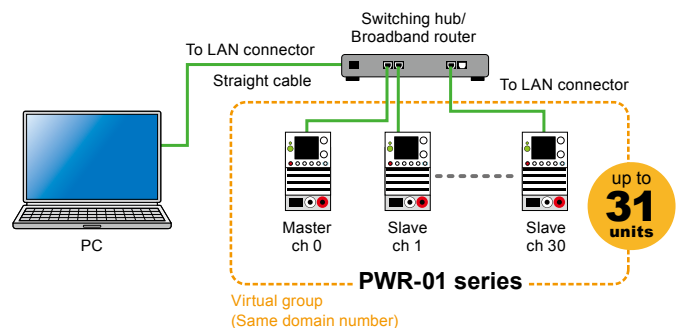

■ Easy access with a built-in web server

Use a browser from a PC, smartphone, or tablet to access the web server built into the PWR-01 series for convenient control and monitoring.

[Recommended browser]

- Requires for the Internet Explorer version 9.0 or later
- Requires for the firefox 8.0 or later
- Requires for the safari/mobile Safari 5.1 or later
- Requires for the Chrome 15.0 or later
- Requires for the Opera 11.0 or later

* Connecting with a smartphone, tablet, etc. requires a Wi-Fi environment (wireless LAN router etc.).



*Screen sample

External analog control function

The PWR-01 series is equipped with external voltage/resistance control, which is necessary for external analog control and monitoring applications for power supply testing. The input external signal and the output status signal can be accessed through the J1/J2 connectors on the rear panel. When using the J1/J2, please purchase the J1/J2 connector plug kit (OP01-PWR-01) option, sold separately.

Controlling the output voltage & output current.

Control using an external voltage.

It is possible to control the output voltage/output current of the PWR-01 series by using an external voltage.

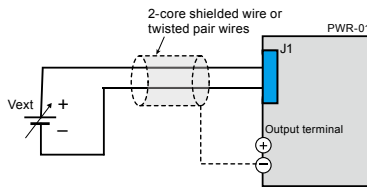

Control using an external resistance.

It is possible to control the output voltage/output current of the PWR-01 series by using an external variable resistor.

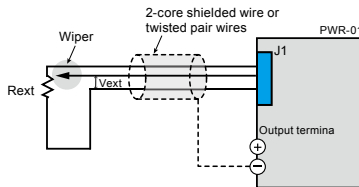

Turning output on and off using an external contact.

It is possible to turn the output ON/OFF of the PWR-01 series by using an external contact.

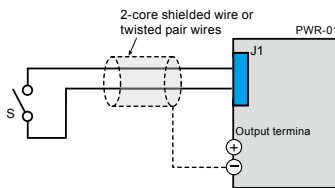

Output shutdown control using an external contact.

It is possible to turn the output OFF of the PWR-01 series by using an external contact.

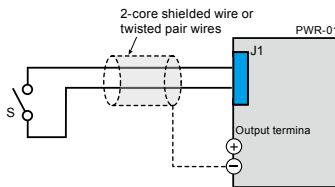

Clearing alarms using an external contact.

It is possible to clear the alarm of the PWR-01 series by using an external contact.

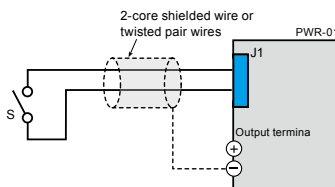

Monitoring operation modes.

External monitoring of the output voltage and output current.

J1 connector pin arrangement



Pin No.	Signal name	Description
J1-1	VPGM	Terminal used to control the output voltage with an external voltage or external resistance. 0 V to 5 V; 0 % to 100 % of the rated output voltage (CF12: LO). 0 V to 10 V; 0 % to 100 % of the rated output voltage (CF12: HI).
J1-2	VMON	Output voltage monitor. 0 % to 100 % of the rated output voltage is generated as a voltage between 0 V and 5 V (CF13: LO) or a voltage between 0 V and 10 V (CF13: HI).
J1-3	REF OUT	Reference voltage for external resistance control. 5.25 V (CF12: LO) / 10.5 V (CF12: HI), maximum output current: 2.5 mA.
J1-4	PRL ON	On when parallel operation is in use and when output is on (output through an open-collector photo-coupler)
J1-5	A GND	External signal common for pins 1 to 3, 6 to 9, 11, 12, 14, 16, and 20. When remote sensing is not used, this is at the same electric potential as the negative output terminal. When remote sensing is used, this is at the same electric potential as the negative electrode (-S) of sensing input.
J1-6	ALM CLEAR	Alarm clear terminal. Alarms are cleared when a low level signal (0 V to 0.5 V) is received or shorted.
J1-7	I SUM	Current output terminal for parallel operation.
J1-8	PRL OUT	Positive output terminal for parallel operation.
J1-9	PRL COMP IN	Correction signal input terminal for parallel operation.
J1-10	A GND	External signal common for pins 1 to 3, 6 to 9, 11, 12, 14, 16, and 20. When remote sensing is not used, this is at the same electric potential as the negative output terminal. When remote sensing is used, this is at the same electric potential as the negative electrode (-S) of sensing input.
J1-11	IPGM	Terminal used to control the output current with an external voltage or external resistance. 0 V to 5 V; 0 % to 100 % of the rated output current (CF12: LO). 0 V to 10 V; 0 % to 100 % of the rated output current (CF12: HI).
J1-12	IMON	Output current monitor. 0 % to 100 % of the rated output current is generated as a voltage between 0 V and 5 V (CF13: LO) or a voltage between 0 V and 10 V (CF13: HI).
J1-13	PRL COM	Common for pin 4.
J1-14	PRL ALM	On when a protection function is activated during parallel operation or when an output shutdown signal is being received.
J1-15	A GND	External signal common for pins 1 to 3, 6 to 9, 11, 12, 14, 16, and 20. When remote sensing is not used, this is at the same electric potential as the negative output terminal. When remote sensing is used, this is at the same electric potential as the negative electrode (-S) of sensing input.
J1-16	SHUT DOWN	Output shutdown control terminal. The output is turned off when set to LOW (0 V to 0.5 V) or shorted.
J1-17	OUTPUT CONT	Output on/off terminal. On when set to LOW (0 V to 0.5 V) or shorted; off when set to HIGH (4.5 V or 5 V) or open (CF15: LO). On when set to HIGH (4.5 V to 5 V) or open; off when set to LOW (0 V or 0.5 V) or shorted (CF15: HI)
J1-18	PRL COMP OUT	Correction signal output terminal for parallel operation.
J1-19	PRL IN-	Negative input terminal for parallel operation.
J1-20	PRL IN+	Positive input terminal for parallel operation.

J2 connector pin arrangement



Pin No.	Signal name	Description
J2-1	STATUS COM	Common for pins 2 to 6. *1
J2-2	OUT ON STATUS	Outputs a signal when output is on (output through an open-collector photocoupler). *2
J2-3	PWR ON STATUS	Outputs a low level signal when the power is on (output through an open-collector photocoupler). *2
J2-4	ALM STATUS	Outputs a signal when a protection function (OVP, OCP, FOCP, OHP, SENSE, AC-FAIL) is activated or when an output shutdown signal is being received (output through an open-collector photocoupler). *2
J2-5	CV STATUS	Outputs a signal during CV mode (output through an open-collector photocoupler) *2
J2-6	CC STATUS	Outputs a signal during CC mode (output through an open-collector photocoupler). *2

*1. The status common is floating (isolation voltage of 800 V or less). It is isolated from the control circuit.
*2. Open collector output. Maximum voltage: 30 V. Maximum current: 8 mA.

J1 and J2 connectors

	J1 connector	J2 connector
Connector type	WF2549-2WR10S3T01 (WCON)	WF2549-2WR03S3T01(WCON)
Housing type	WF2549-2H10W01 (WCON)	WF2549-2H03W01 (WCON)
Terminal (pin)	WF2549-TPS302 (WCON)	WF2549-TPS302 (WCON)
Wire diameter (core wire)	AWG20 to AWG24	AWG20 to AWG24
Manual pressure welding tool	SN-28B (IWISS) or an equivalent product	SN-28B (IWISS) or an equivalent product

CONFIG setting is easy for ON/OFF settings with external contact points that can be easily accessed from the front panel.



